 ĐURO ĐAKOVIĆ SPECIJALNA VOZILA d.d. <small>SLAVONSKI BROD • HRVATSKA</small>	Four-axled WAGON Shimmns	TU-001SI AR
---	-------------------------------------	--------------------

USER MANUAL FOR WAGON Shimmns

Date: 04.2021.	Made by: Josip Živković, dipl. ing.	Checked by: Šime Marijić, mag.ing.mech	Approved by: Šime Marijić, mag.ing.mech
-------------------	---	--	---

This document is the property of Đuro Đaković Specijalna vozila

1. General

Purpose of the wagon:

The wagon is intended for transport of coiled sheet metal, which is loaded in horizontal position and protected from atmospheric influences. For protection, there is a folding tarpaulin on supporting wheels. It is used for covering the wagon and can be locked on front and rear wall. There is an anti-condensation layer in the upper part of the tarpaulin, which prevents the condensate from falling on coiled sheet metal. When the tarpaulin is open, it uncovers more than 3/5 of the wagon loading length. The wagon is equipped with saddles, used for coiled sheet metal acceptance. There are security devices mounted on the saddles, which prevent lateral displacement of the coils.

Wagon overview:



Scheme of max. load of cradles:

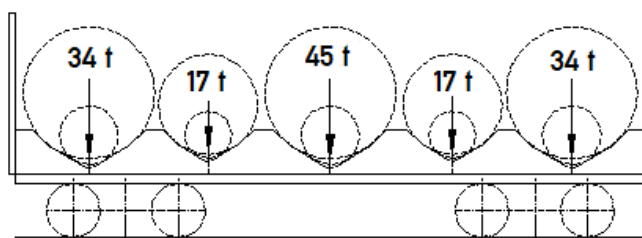

Saddle	1	2	3	4	5
Φ min. mm	1000	800	1000	800	1000
Φ max. mm	2250	1700	2700	1700	2250
max. weight, t	34,0	17,0	45,0	17,0	34,0

2. Instructions for locking mechanism

The wagon is equipped with a locking mechanism on each front wall. The locking mechanism is operated from the unloading platform, but it is also possible to operate it from the ground. Locking and unlocking is performed on one side of the wagon. The mechanism is unlocked by lifting handle 1 in figure 1, which releases the main lever of the locking mechanism 2.

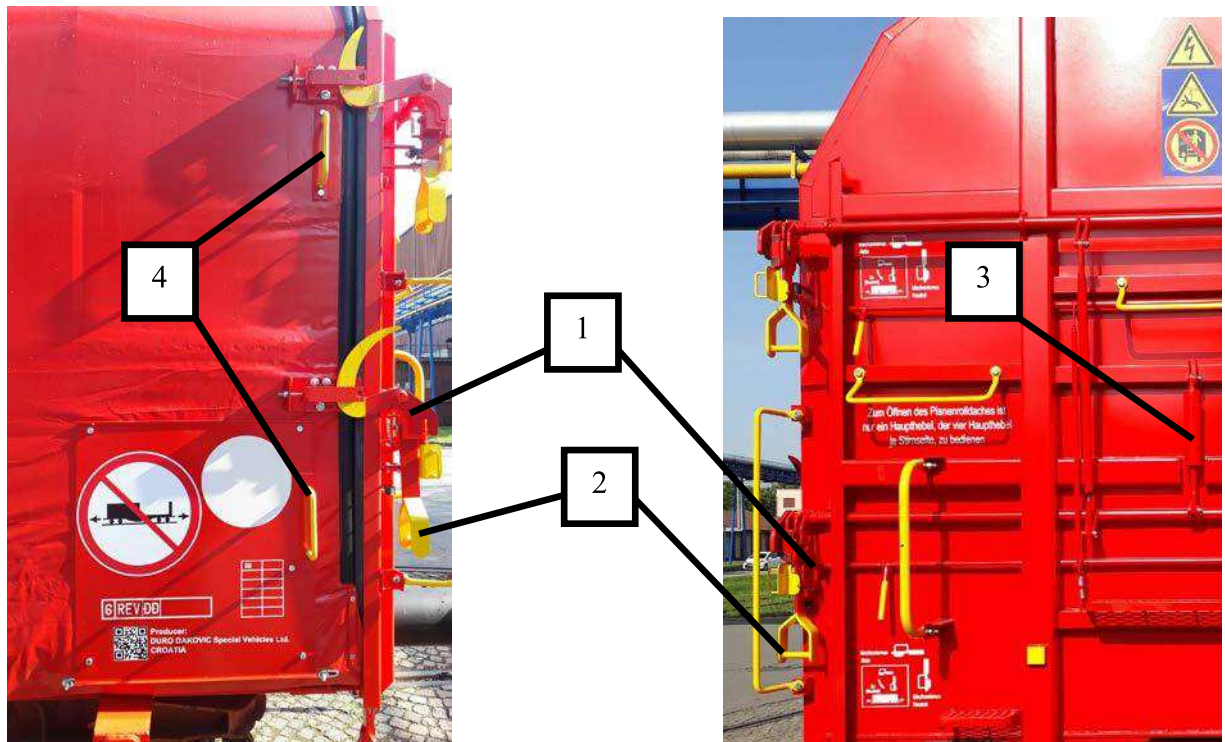

Figure 1 *Mechanism for locking tarpaulin*

Opening the tarpaulin:

To open the tarpaulin, use only one main lever of the four main levers per front wall:

- 1) By unfolding the lever (signal flag) on the main lever selected for opening, the lever is engaged in the locking mechanism
- 2) Unlocking the locking mechanism

For this purpose, the spring-loaded locking mechanism must be pulled up by means of a hand lever.

- 3) The selected main lever (2) with the signal flag extended, must be raised to the upper position to fully unfold the sickles from the locking position. A spring (3) takes over the task to keep the main lever in the open position. The tarpaulin is opened by pulling it along the carriage. The tarpaulin can be secured in the open position, with a manually operated tarpaulin brake, against automatic rolling.

Should it become necessary to fully load the wagon on the opposite end wall, the originally opened side of the wagon should first be closed and locked.

Closing the tarpaulin:

- 1) The possibly activated tarpaulin brake must be opened so that the tarpaulin can be closed by hand.
- 2) Close the tarpaulin by hand. With the activation of the activated main lever downwards, the tarpaulin is pulled by the sickles in the end-mounted rubber seal.

- 3) If the activated main lever is pressed in the lowest position (closed), the spring-loaded locking mechanism must engage and thus lock the lock completely.
- 4) The lever (signal flag) has to be folded in again to ensure a safe shunting and transport of the vehicles.

After locking it is imperative to check on both faces whether the locking mechanism is correctly closed and locked. The proper position of all hooks must be ensured.

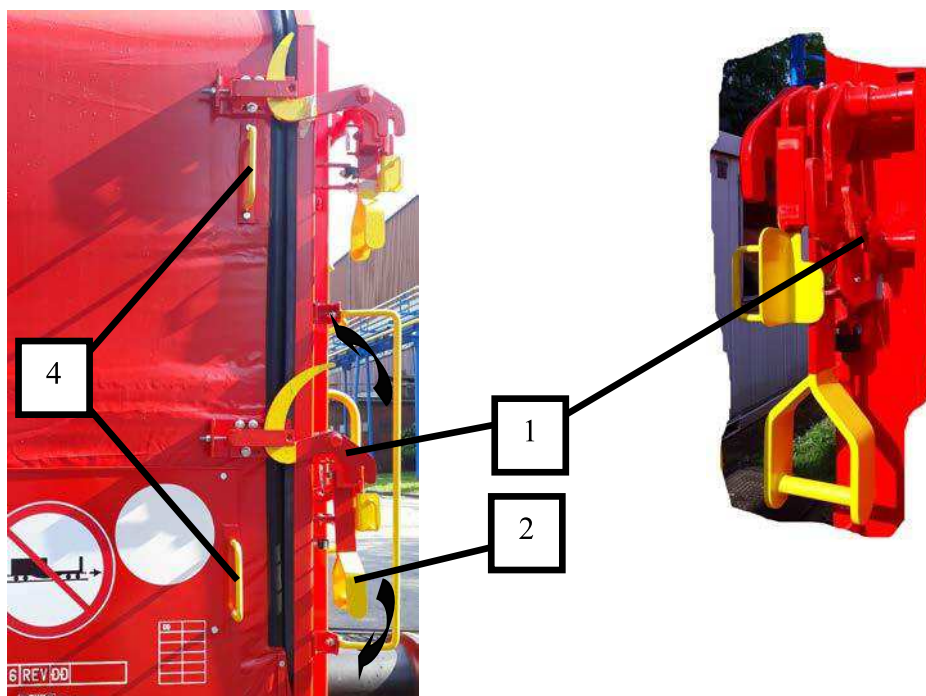

Figure 2 Close position of locking mechanism

Attention!

It is FORBIDDEN to move opened or unlocked car!



Figure 3 *Open position of tarpaulin*



Figure 4 *Open and closed position of the tarpaulin brake*



CAUTION:

Handling with the tarpaulin is only possible when both tarpaulin brakes, left and right (1), are in open position!

⚠ For opening tarpaulin brake, positioning of lever (2) must be according to the figure 6.

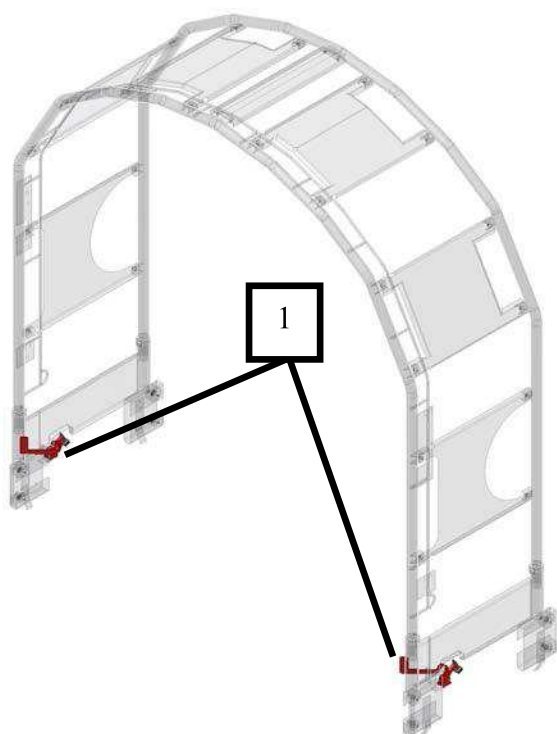

Figure 5 tarpaulin brake

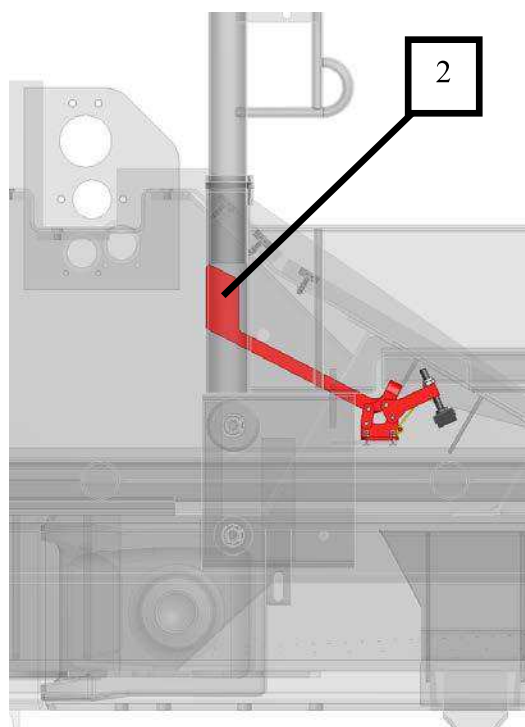

Figure 6 Open position of the tarpaulin brake

3. Instructions for coil security devices

Figure 8 shows the securing device mechanism as viewed from wagon lateral side. Mechanism can be operated in two ways:

1. Quick movement - pushing the arm (1) directly by hand,
2. Fine movement – moving the arm by handwheel (3) rotation.

Two ways of operation are implemented to reduce the time needed to tighten the coils. If quick movement is used, quick movement should be used first, to bring the arm close to the coil, and then tightening of the coil should be finished by fine movement.

In case only fine movement is used, there is no need to use the quick movement.

The operation of the mechanism from the operator's point of view is as follows:

3.1 Quick movement

Referent parts are pointed out in figure 7.

To quickly move the arm (1), first push the lever (2), located on the arm itself, in the direction indicated by the arrow on the arm, then push or pull the arm in wanted direction. The procedure is equivalent for quick movement of all other arms on the wagon.

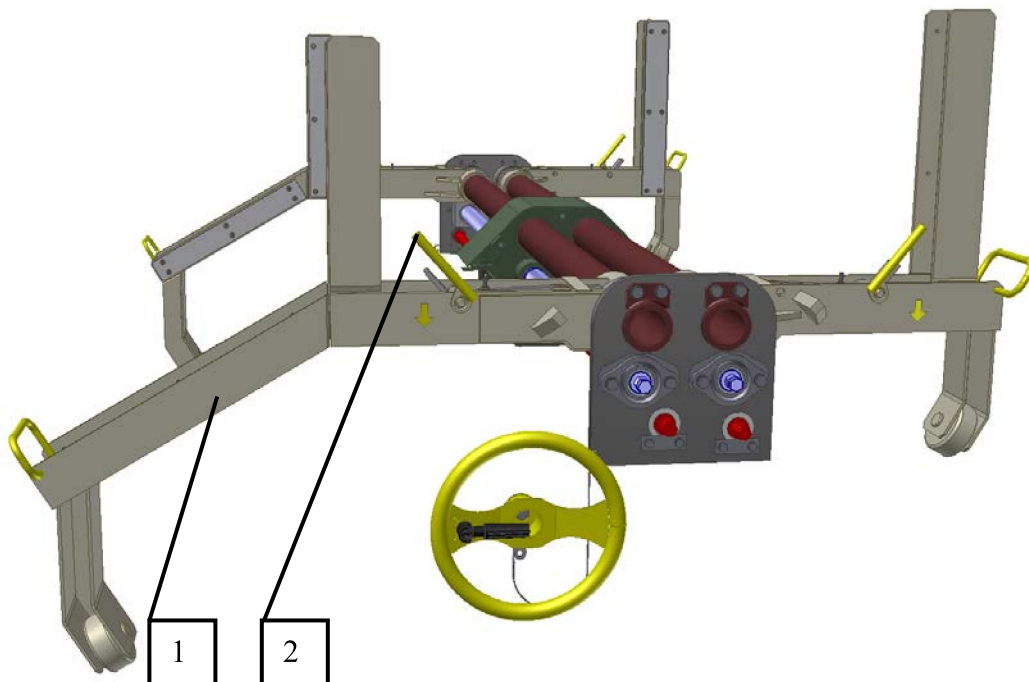
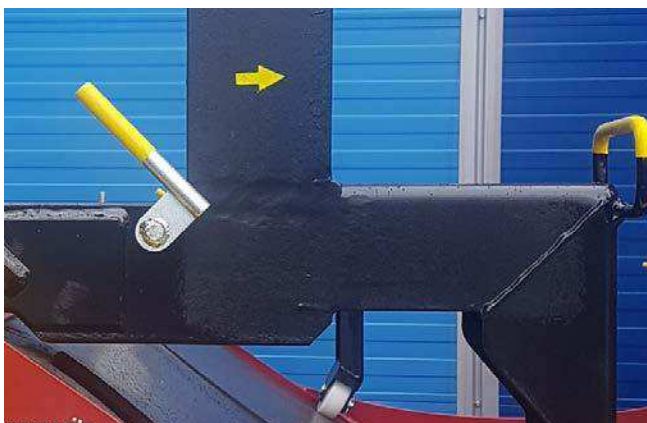
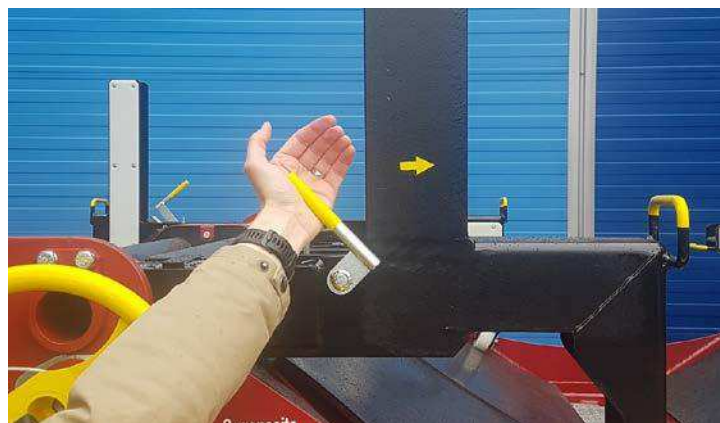

Figure 7 Quick movement of arms



a) "Locked" position of lever (spindle)



b) Handling the lever in direction of arrow



c1) "Open" position of lever (spindle)



c2) "Open" position of lever (spindle)

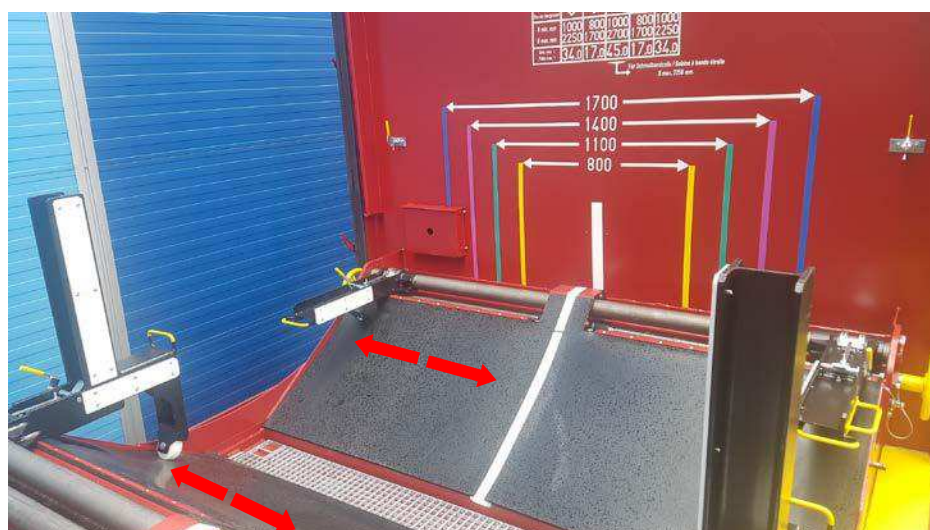

d) Shifting the arms

Figure 8 *Shifting the arms by pushing*



CAUTION:

⚠ After using the arms via quick movement, in case when the lever does not lower to position “locked” turn the handwheel (acc. to p. 3.2) until the forming thread connection screw/nut



Figure 9 Lever not in “locked” position, no contact with levers



Figure 10 “Locked” position of lever, thread connection screw/nut, contact with levers

3.2 Fine movement

Referent parts are pointed out in figure 11.

Before the operation of the securing devices mechanism, the handwheel (3) is placed on a fixed location on the wagon, not connected to the mechanism. If the mechanism should be operated, the operator first needs to attach the handwheel to the mechanism. The handwheel is easily removed and attached.

The mechanism has left and right side, for tightening left and right coil. To move the closer left arm (1), the handwheel (3) needs to be attached to the left side spindle (4). To move the closer right arm (6), the wheel (3) needs to be attached to the right-side spindle (5).

By rotating the handwheel, the arm is moving away or towards the central plane of the wagon, depending on the handwheel rotation direction.

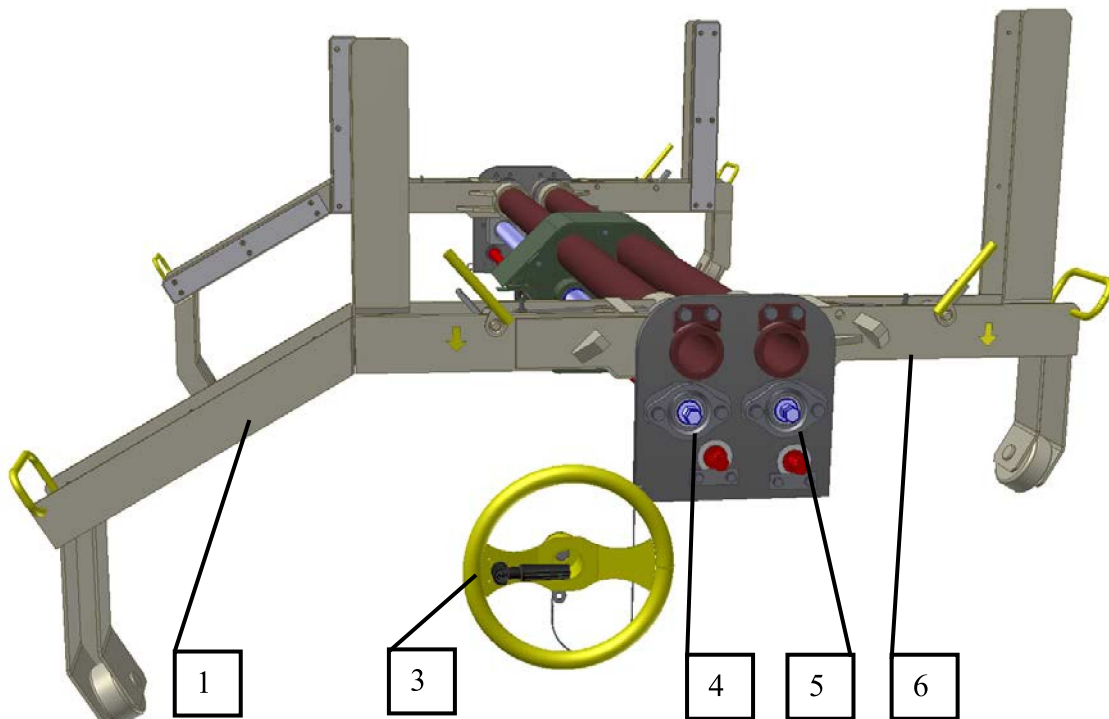

Figure 11 *Fine movement of closer arms*

Figure 10 shows operation of opposite arms. To move the opposite left arm (7), the handwheel (3) needs to be attached to the left side shaft (8). To move the opposite right arm (10), the wheel (3) needs to be attached to the right-side spindle (9).

By rotating the handwheel, the arm is moving away or towards the central plane of the wagon, depending on the handwheel rotation direction.

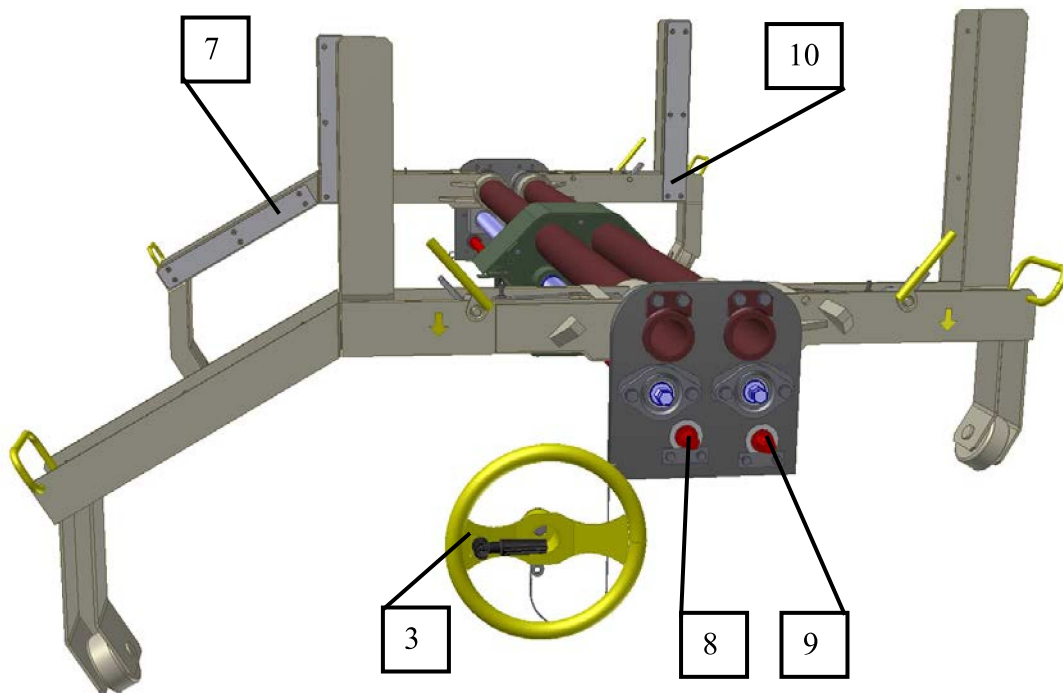

Figure 12 *Fine movement of opposite arms*



CAUTION:

- 1 After using the handwheel, return it to the resting (fixed) position on the wagon.
- 2 The wagon must not be moved unless coils are properly secured with securing devices.
- 3 The mechanism of each arm is spring-operated. Make sure the springs are functional before releasing the wagon into traffic. In case spring or any other part of the mechanism is faulty, it must be repaired or replaced before releasing the wagon into traffic.

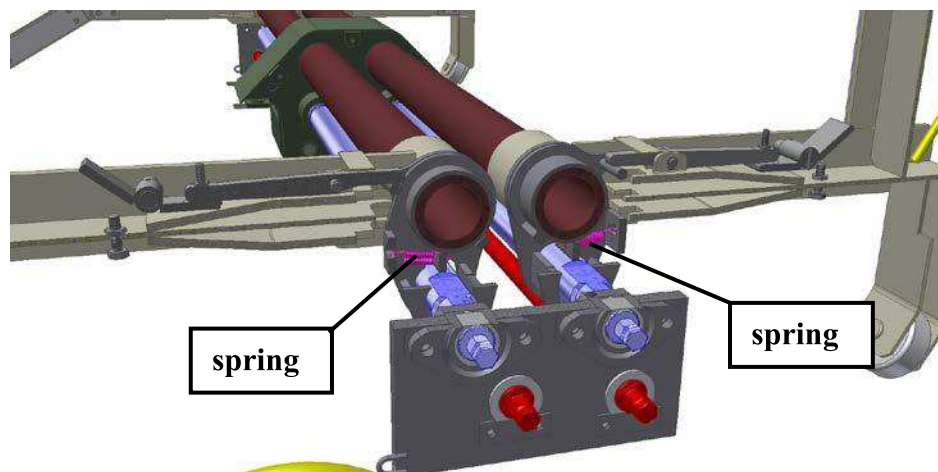



Figure 13 *Locations of mechanism springs*

 **Important!!** Maximum torque is 30 Nm, and speed 300 min⁻¹ 

When using pneumatic or electric tools to operate the load securing arms, the maximum torque of 30 Nm and a maximum speed of 300 min⁻¹ must not be exceeded.

Parts of the coil securing arms that come into contact with the coils are provided with 10 mm thick polyamide plates to protect the plate from damage.

The coil securing arms are equipped with polyamide rollers for ease of operation, which move along the plywood surface of the securing arms.

3.3 Loading and unloading of coil cradle:

The wagon can be loaded and unloaded from above with a crane and from the side, with hose, with a pair of pliers or with a magnet.

To simplify coil positioning during loading, white strips are placed on the inside of the entire wagon cradles.

To protect the coils, split plywood is attached to the cradle surface and attached to the top. Missing and defective plywood must be replaced to avoid damage to the coils.



CAUTION:

Lifting the arms is only possible when arms are in maximum outer position!

1 For the front wall securing arms, positioning must be according to the figure 16.

2 For the other securing arms, positioning must be according to the figure 17.

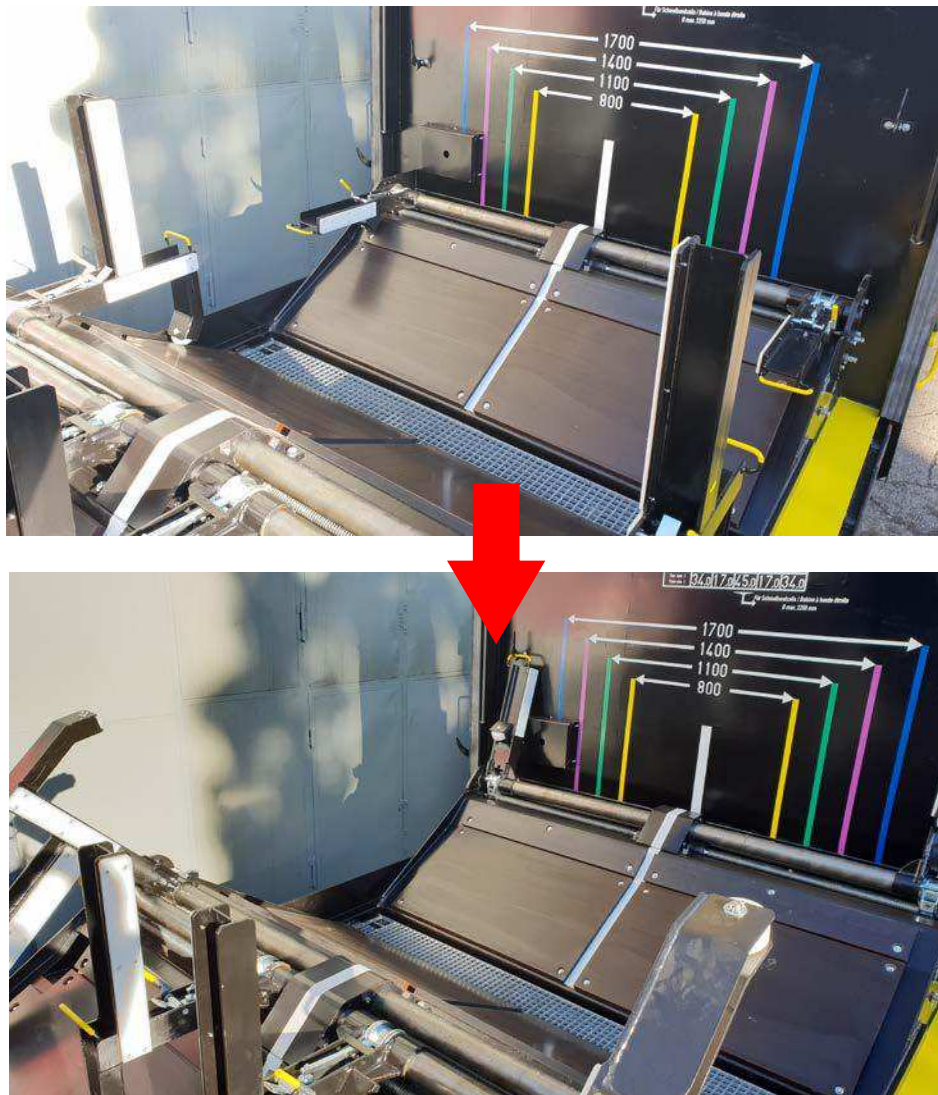

Figure 14 *Closed and open position of arms*

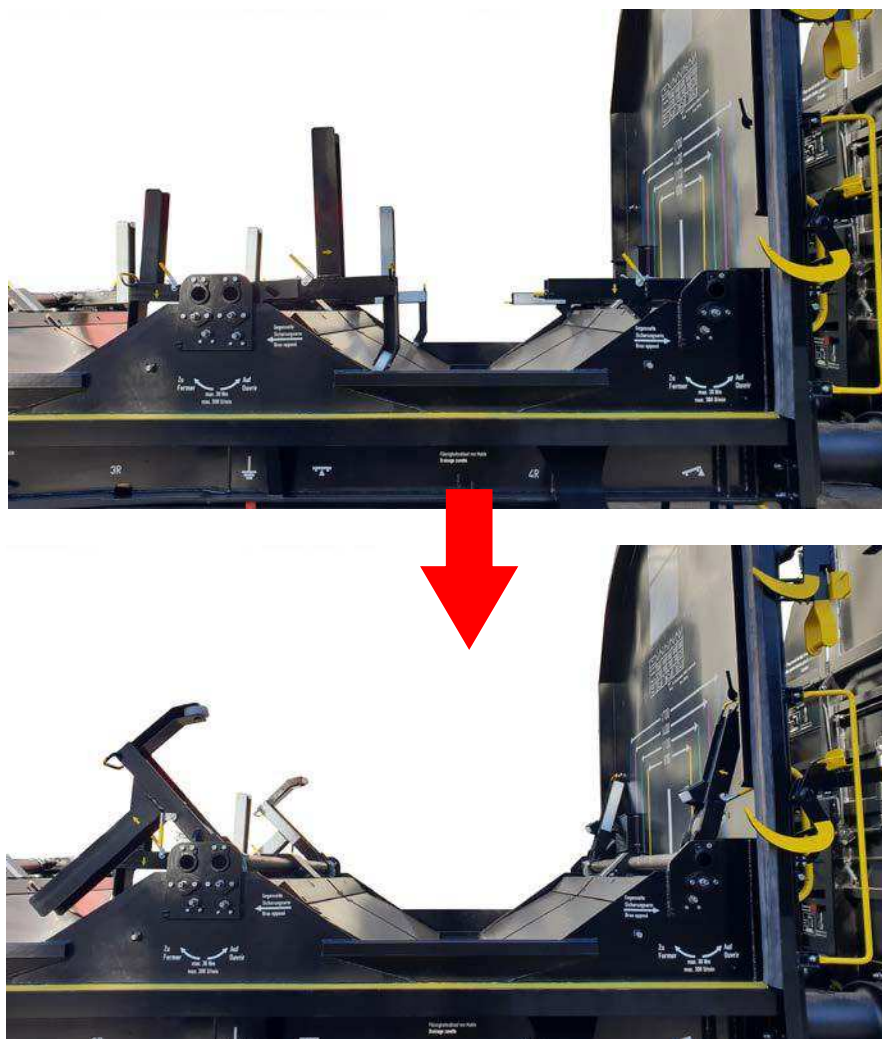

Figure 15 *Closed and open position of arms*

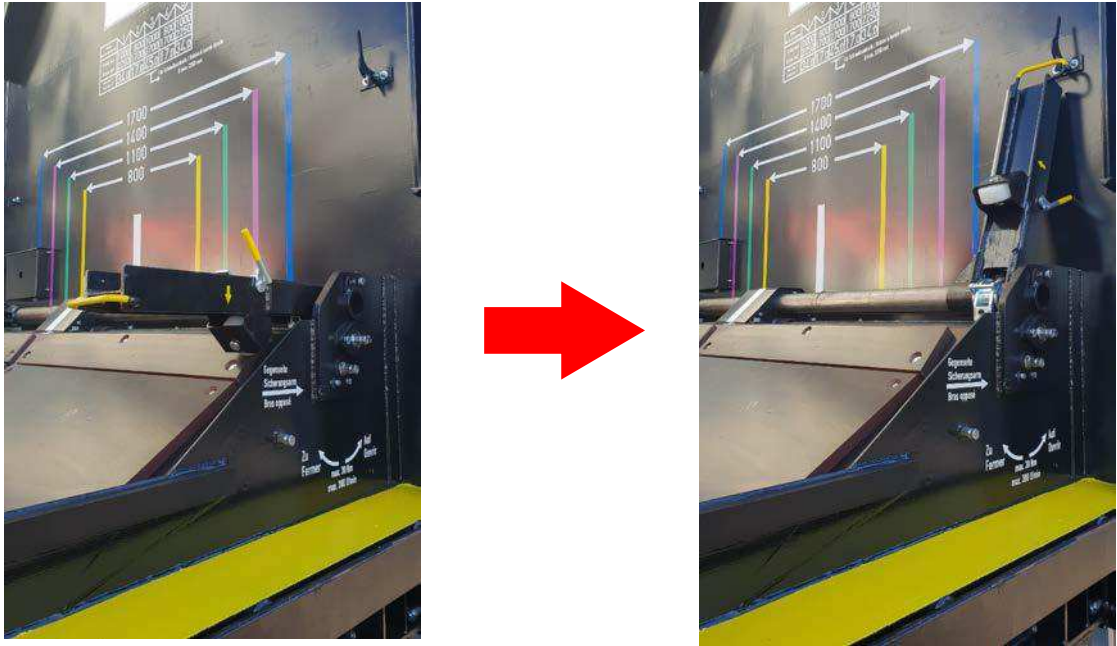

Figure 16 Positioning the arm on the front wall



Figure 17 Positioning the other arms

4. WAGON CROSS-OVER

Steps are mounted on one front wall, which make it possible to cross from one side of the wagon to the other.

It is strictly forbidden to climb higher on the wagon than the steps allow it, due to danger of electrocution, like the warning sign on the upper part of the front wall is showing.



Figure 18 Steps for crossing the wagon



!!! Caution – Danger of slipping due to weather conditions!!!

(See "USER MANUAL FOR WAGON Shimmns" Pt. 1)

The wagon's treads and longitudinal beams are equipped with an anti-slip coating. Depending on weather conditions, they may be covered with drifting snow or ice.







To avoid any danger of slipping, it needs to be removed pre-emptively prior to ascending the vehicle





!!! Caution – Secure the hand wheel and the grab handle!!!

(See "USER MANUAL FOR WAGON Shimmns" Pt. 3, 3.2)

- a)  **When the hand wheel is not in use, it is imperative to ensure that it is securely fastened in the storage position provided for that purpose,** and that it cannot detach from its holder. (The hand wheel is placed on the designated support and latched onto the pin). **It is not permitted to store the hand wheel inside the wagon.** 
- b)  **Once loading/unloading is completed, it is imperative to check and ensure that the grab handle attached to the hand wheel is folded in.** 





!!! Caution – Opening and closing of the wagon!!!

(See "USER MANUAL FOR WAGON Shimmns" Pt. 2)

The main levers for opening/closing the tarpaulin cover situated on the front end of the wagon can only be operated on one side at a time.



The wagon needs to be closed from the same position as it has been opened.





!!! Caution – Loosening the manually operated tarpaulin brake!!!

(See "USER MANUAL FOR WAGON Shimmns" Pt. 2. ff)

The wagon is equipped with a manually operated tarpaulin brake. When the brake is activated, it ensures that the tarpaulin does not automatically move.



In order to prevent damages, PRIOR to closing the tarpaulin, it is imperative to ensure that the activated tarpaulin brake is loose and opened. This requires a visual inspection.



!!! Caution – Distance between treads!!!

(See "USER MANUAL FOR WAGON Shimmns" Pt. 1, 4)

The distance between the first and the second tread is greater than is the norm. A grab handle has been installed next to the treads for additional security.

 **For safety reason, it is important to note that one must face the vehicle when descending from the wagon.**



 Generally, it is only permitted to access the wagon via the treads marked and installed for that purpose. Any other means of access or crossing are prohibited.





!!!Caution – Stay on the wagon!!!

(See "USER MANUAL FOR WAGON Shimmns" Pt. 3.3)

The passages between the cradles as well as the lubricated shafts in the cargo area are exposed and are not protected by an overpass.



It is explicitly forbidden to remain between the fixation arms in the padded area, as well as within the white lines. Staff must always access the wagon from the side.





!!! Caution – Careful handling of the fixation arms!!!

(See "USER MANUAL FOR WAGON Shimmns" Pt. 3, 3.3)

The inside of the fixation arms is protected by a synthetic lining.



To avoid any damage to the synthetic lining, the fixation arms must be positioned in the maximum utmost position while loading or unloading the coils.

